

DORNIER

INSIDER

Customer magazine of Lindauer DORNIER GmbH / Jubilee edition / September 2000

50

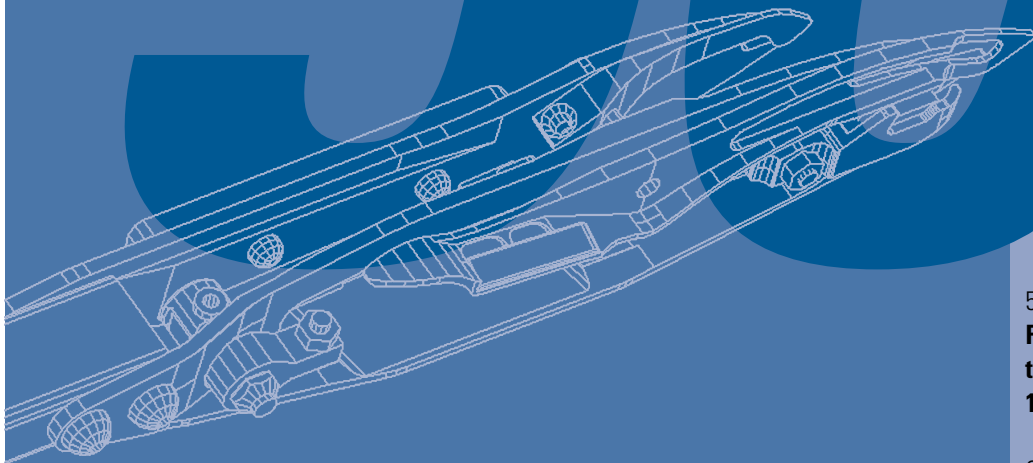

50 years Lindauer DORNIER GmbH
**From human flight
to flying threads
1950 – 2000**

Congratulations
**DORNIER customers
celebrate their own jubilee**

Customers – suppliers –
communication via DoNet
Networking reduces costs

Lindauer DORNIER GmbH: facts and figures in jubilee year 2000

Ca. 1,500 employees

Locations in Lindau, Pfronten, Esseratsweiler, subsidiary sales company American DORNIER Machinery Corporation in Charlotte, North Carolina and a sales office in Beijing, China.

Gross sales in 1999 about DM 400 million; three quarters from weaving machines and one quarter special machines.

Exports 87%; almost 40% of production supplied to the industrial countries in the EU, followed by the USA. Increasing share of markets in Eastern Europe, Near East, Asia and South America.

Lindauer DORNIER GmbH is the largest weaving machine manufacturer in Germany and one of the most important producers of weaving machines worldwide.

In special machine construction the company maintains the position of a world leader in the design, engineering and supply of installations for the production of synthetic stretched film.

As a result of a patented circular expander the company has created a name in the field of textile finishing machines for the finishing of circular knit goods.

For over 40 years Lindauer DORNIER GmbH has been well known as a specialized producer of dryers for all types of flat goods.

Contents

50 years Lindauer DORNIER GmbH From human flight to flying threads	4
--	----------

Congratulations Hi-tech textile enterprise of European class and stature 175 years Arnold Kock GmbH & Co. KG in Steinfurt, Germany	11
---	-----------

A passion for textiles 175 years Weisbrod-Zürrer AG in Hausen am Albis, Switzerland	12
--	-----------

“Obsession” the finest worsted fabric from 13.9 micron merino wool 100 years Bower, Roebuck & Co Ltd. in Bradford, United Kingdom	13
--	-----------

Precious fabrics for the very fashion conscious 75 years Wilhelm Zuleeg GmbH in Helmbrechts, Germany	14
---	-----------

Kissing frogs, or how to find and develop speciality markets 75 years Southern Mills, Inc in Atlanta, USA	15
--	-----------

Networking reduces costs Customers – suppliers – communication via DoNet	16
---	-----------

Extensive flexibility through adaptable machines Strategy: system family consisting of rapier and airjet weaving machines	19
--	-----------

Watertight chances of success in the field of protective clothing Sioen Industries NV in Ardoorie, Belgium	22
---	-----------

**For this edition of the INSIDER as well
as further information go to our website
<http://www.lindauer-dornier.com>**

Dear Readers,

Our company is 50 years old this year, our customer magazine "Insider" 10 issues old. Reason enough to depart from the usual style of actual customer profiles and technical descriptions covering product development and devote a few sentences to the birthday children.

When almost 50 years ago the first company cars for our service technicians were purchased, to provide them with a quicker and better means of transport to our at that time almost exclusively German customers, our land was a picture of a country divided after the war and to a great extent lying in ruins. In Germany at that time, in addition to the young Lindauer DORNIER 15 other companies were trying to develop weaving machines, or looms as they were then called.

Forty years later in the fall of 1990, as we drafted the first issue of our new customer magazine, Germany had not only become the most important exporting nation in the world, but was also once more a unified country. The fax machine and PC had improved our communication with our customers enormously. Our level of exports had reached 72% and in Germany at this time there were still three independent weaving machine manufacturers.

Today – in the year 2000 – data communication via the Internet and the use of miniaturized mobile phones and computers has made us accessible from practically anywhere in the world and round the clock. Germany is one of the richest countries in the world, Europe a reality, and we look back over almost 50 years of peace in our region. In Germany only one independent manufacturer of weaving machines is still in existence: Lindauer DORNIER GmbH, 87% of our production being exported.

In addition to a strong feeling of gratitude and a certain degree of astonishment one experiences when looking back over such a long, happy and successful time, the question arises as to why particularly our company came through these 50 years of rapid development better than others.

Anyone searching for an answer to this question should while taking a tour of our works, in addition to our modern machine tools, machines and computers, ask also to be shown a small inconspicuous building on our campus – our training workshop for apprentices.

Already in the first year of our existence in 1951, 25 young people were trained there in what for us were the most important professions.

Since then almost 1000 young people have left this building as skilled workers and some of them – today holding high positions – have made a significant contribution to the success of our company.

Not just the application of the latest technologies, but their thoughtful and considered utilization by male and female employees with inventive spirit and a strong feeling of personal responsibility have decisively contributed to our progress over the last 50 years.

Therefore we dedicate this edition of our INSIDER not only to our loyal customers and employees, but in particular to those 88 young people currently being trained in our company. It is our sincere wish that some of them will go on to give our company new impetus in order for us to surprise our customers with intelligent and innovative solutions also in the coming years.



Peter Dornier
Chairman of the Board
Lindauer DORNIER GmbH



Peter D. Dornier
CEO and Spokesman for the Board
Lindauer DORNIER GmbH

50 YEARS LINDAUER DORNIER GMBH

A half century has elapsed since the founding of Lindauer DORNIER GmbH, a half century during which the company has earned a worldwide reputation in weaving machine manufacture and the production of so-called special machines. With technologically leading products, recognizing market opportunities and exploiting these, with a wealth of ideas and conscious of quality, DORNIER has up to this day maintained a strong position in the face of international competition, mostly larger and not seldom being in a position to profit from local cost advantages.

Lindauer DORNIER GmbH today

Customer requests and requirements are perceived by DORNIER as chances to improve. Correspondingly, the approach to customer requests throughout the entire company is very apparent – from the development and engineering stages through to worldwide customer service. This list of examples representing improvements and product optimization, based on close cooperation with customers, is endless.

The lead position of the company is also thanks to a highly motivated workforce, which maintains considerable interest in technical progress and has made exceptional contributions in this respect. It is therefore a matter of course that the employees concerned are also included as inventors in patent applications.

From the very beginning the rigorously applied modular construction principle in development engineering and fabrication is one of the major facts at this time regarding controlling costs. This strategy is of decisive significance for a company producing small series of machines and concentrated on maintaining the technological edge. Also in the case of the special machines, the second largest business segment of Lindauer DORNIER, the same principles of modular construction apply. The special machines segment includes not only film stretching machines for the manufacture of magnetic tapes for video and sound recording, photographic and packaging film, but also industrial dryers and machines for textile finishing and sludge drying, the latter bringing the company into the field of environmental protection.

1950 to 1955: from human flight to shuttle flight

Lindauer DORNIER GmbH had its beginnings at the end of the Second World War. Following the unconditional surrender aircraft construction was forbidden in Germany, the DORNIER facilities either destroyed or dismantled. As a result DORNIER the aircraft construction company had to find another basis for its operation. The DORNIER works in Pfronten were still intact and it was only through a fortunate occurrence that this facility had not been confiscated by the Allies. This facility started to manufacture all kinds of what were considered useful products at that time. The DORNIER weaving machine manufacturing program originated at the Pfronten works. The ERBA textile company began to resume production and urgently required some parts for the old looms. DORNIER's Pfronten works supplied the required parts, already optimized to specific requirements.

DORNIER moved back into the Lindauer-Rickenbach works after this had been released by the French forces, and founded

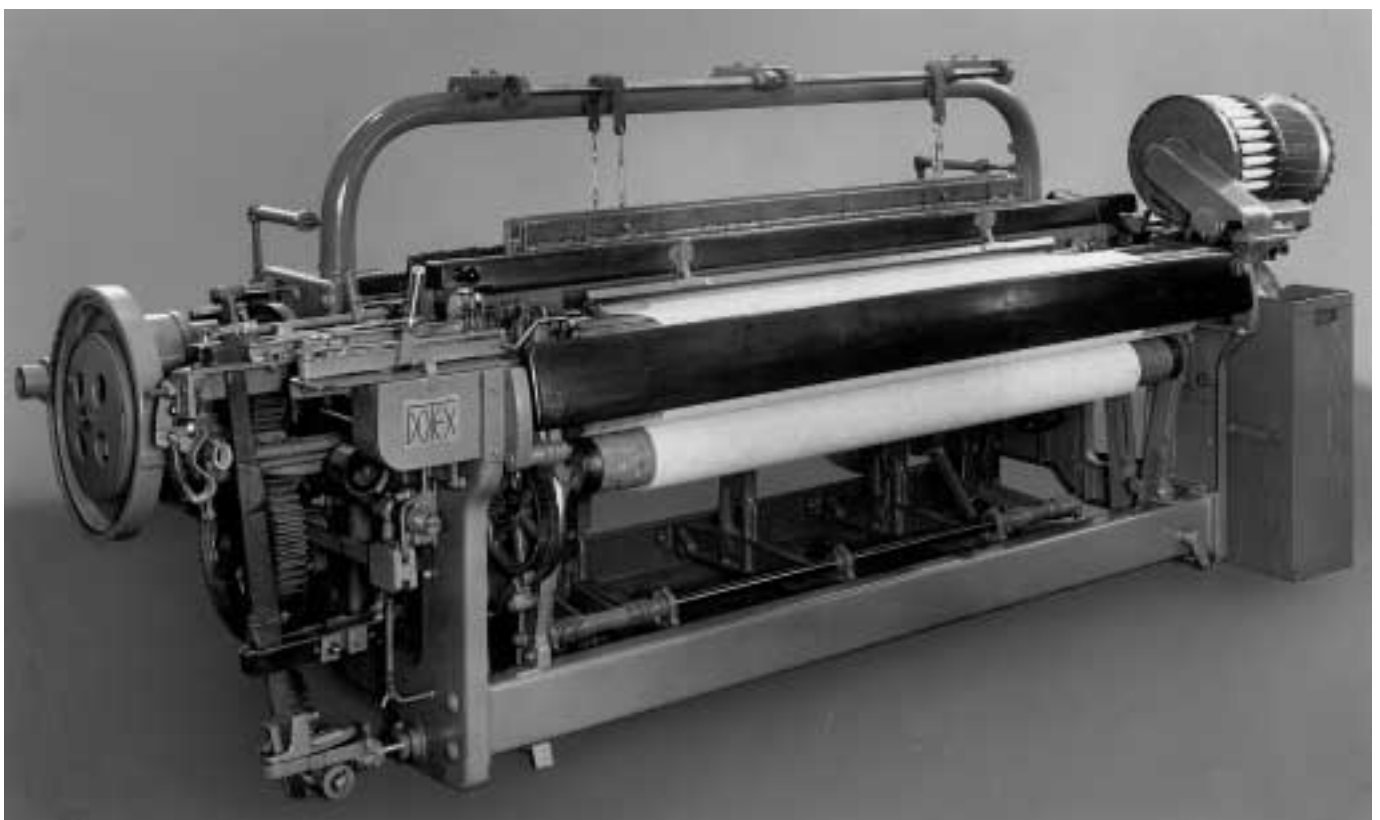

The first DORNIER loom, Type DoTex

Prof. Dr. Claude Dornier

Claude Dornier was born in the Allgäu region on May 14, 1884. As a qualified engineer Claude Dornier took up a position in 1910 with Graf von Zeppelin.

During this period materials such as wood, piano wire, bamboo and cloth dominated aircraft construction. Claude Dornier was able to build airplanes and flying boats entirely from metal, and of these the DORNIER Whale has a place in history. Various famous pioneer aviators such as the Spaniard Ramón Franco, Wolfgang von Gronau and Walter Mittelholzer piloted flying boats from the Whale series.

In 1929 Claude Dornier presented a sensation: the 12-engine flying boat DoX, in its day the largest aircraft in the world. Used on a spectacular expedition to Africa, North and South America, the Do X caused an international sensation.

The high point of the propeller era was reached with the introduction of the Do335 in 1943. The concept for this unusual aircraft was developed by the second oldest son of the founder of the company – Peter Dornier, who was awarded the Lilienthal Prize for achievements in aviation.

“Lindauer DORNIER GmbH” in July 1950. The first task was to build a loom for ERBA. The aircraft engineers had neither technical drawings nor a precise idea of how a loom worked. All the more astonishing that under the direction of the one time aircraft engineer Hermann Zippel the first “DoTex” loom was supplied after only six months. And even more astonishing, the machine proved itself right from the outset. Soon the 100th loom could be delivered. In postwar Germany there was an enormous pent up demand for textile products. The company became profitable in 1952 with orders from Eisenlohr in Reutlingen and Schöpflin in the Black Forest. But the



The first DORNIER cardboard dryer at the Swiss company Christ

textile industry was still skeptical as regards DORNIER. When the DoTex loom was shown for the first time in May 1951 at the Hannover Industrial Exhibition, it was described half in ridicule and half in acknowledgment as “the flying loom”, since the name DORNIER was still synonymous with aircraft construction.

In the mid 50’s DORNIER introduced its high speed “Automatic Flyshuttle Loom” the SW4, with a revolutionary innovation, which was patented for the first time. This related to the design of the flyshuttle box, specifically the receiving mechanism for the flyshuttle where the braking and guiding elements controlling the position of the flyshuttle were separate entities. The growing interest in DORNIER automatic flyshuttle looms led to the appointment of agents in important export markets such as Italy, France, Spain, Portugal, Greece and Turkey. Textile finishing machines were also required by the textile industry. As a result of a licensing agreement with Messrs. Haubold, a company that had made a name for itself in this field prior to the war, Lindauer DORNIER Special Machines Division was started to manufac-

ture machines for drying, bleaching, dyeing and finishing. The experience gained led to other products. At the request of Messrs. Christ in Thal, Switzerland, a new type of jet dryer for the drying of cardboard was developed. The newly gained experiences were invaluable in the heat treatment of flat materials utilized in subsequently developed products.

Polyester appeared during the 50’s and was utilized for the manufacture of photographic and X-ray film, later also for magnetic tape for sound and video recording, as well as computer tape. Again it was possible as a result of a customer request and the Haubold experience, since this company had supplied a modified textile tenter frame to IG Farben, to develop the first industrially applied DORNIER film stretching machine. Important customers of our film stretching machines were and still are almost exclusively large enterprises engaged in the manufacture of stretched film and foils such as BASF and Hoechst in Germany, Agfa Gevaert in Belgium, Montecatini in Italy, Rhone-Poulenc in France, Celanese, Kodak, DuPont and 3M in the USA, Fuji and Toray in Japan, and Imperial Chemical Industries (ICI).

Lindauer DORNIER Film Stretching Machines

During the manufacture of film and foil materials a synthetic granular material is melted in an extruder and is processed into a relatively thick prefilm material as it passes through a series of cooling rollers. In a series of cooling and heating phases these films must be "stretched" in a longitudinal and transverse direction until they reach a precisely defined thickness. The decisive element in the transverse stretching of the film are the clips, which must hold both thick and thin films with absolute security.

In 1955 after a decade of interruption aircraft construction was again permitted in Germany. As a passionate aeronautics engineer, Peter Dornier made significant contributions to DORNIER GmbH in Friedrichshafen and Munich parallel to his efforts to build up Lindauer DORNIER GmbH.

1955 to 1961: success with automatic flyshuttle looms and special machines

The initial success with the automatic flyshuttle loom was encouraging, but it was

difficult to compete against the old established and mostly Swiss manufacturers. A small team of engineers under the direction of Hermann Zippel doggedly pursued the development of the high speed automatic flyshuttle loom. Gross sales increased. In 1957 the first export order was concluded with the Turkish textile concern Milli Mensucat in Adana.

Sales and customer service were continually being strengthened. Not only were trained and experienced technicians utilized for installations, but also in sales discussions with prospective customers. What was considered sensational at that time was the flight of Peter Dornier, Hermann Zippel and Dieter von Gehlen in a DORNIER aircraft of the Do27 series to Rheine in Westphalia to conclude a large order with the weaving company Hecking located in Neuenkirchen.

In the meantime Lindau was feverishly working on a prototype machine, which would eventually have a decisive influence on the market share in film stretching machines. In this new machine roller clips were used for the first time. With this in-house development of this technologically vital component DORNIER became independent of subsuppliers and cooperating partners. Gevaert purchased the machine for what at the time was the

princely sum of DM 400,000. In those days one could purchase 4–6 single family homes or 40–50 automatic looms for that amount. Each individual roller clip cost DM 400, the equivalent of a month's salary for a qualified technician at that time. In 1961 the leader of the country Francisco Franco, decreed that a state textile industry was to be developed in the south of Spain. Don Francisco Ortiz-Enchaque, general director of Construcciones Aeronauticas, remembered that his old aircraft engineering friend, Prof. Claude Dornier, also had something to do with textile machines. As a result DORNIER arranged its first licensing agreement in Spain. It didn't take long before the first SW4 automatic loom was started up with a bang on the floor rails in the aircraft hangar of CASA in Cadiz. This hangar had been used during the mid 30's to launch the DORNIER Whale flying boats.

1961 to 1969: the road to the rapier weaving machine

DORNIER was well established on the international market with its automatic flyshuttle loom. Annual gross sales had reached DM10-11 million. During these years Peter Dornier developed a vertical take-off and landing aircraft commis-



View of a DORNIER transverse stretching machine, part of a complete film stretching machine



Prof. Dr. Claude Dornier with his wife Anna and their two sons Claudius (2nd from left) and Peter (right)

sioned by the Federal German Department of Defense. His concept of using four auxiliary engines mounted on the wingtips to provide additional lift received a lot of attention from the international aircraft industry.

The rapid pace of development in the post war years had also not let up in the textile machinery industry. Already in the early 60's some manufacturers were experimenting with shuttleless weaving machines. With these machines the intention was to achieve a more economical and flexible weaving system. Hermann Zippel, the all round genius at Lindauer DORNIER responsible for engineering and sales, began to develop his initial ideas in light of this new technology. Nobody had any idea at this stage how long the road to travel from the initial concept to a tried and proven shuttleless rapier weaving machine would really be.

The first experiments for a shuttleless rapier weaving machine were carried out in complete secrecy under the direction of Peter Dornier. At that time a new person joined the team as an inventor and even without any technical experience he soon won the admiration of Peter Dornier. This was Nikolaus Kokkinis, a Greek national who started his career at Lindauer DORNIER GmbH as a design engineer in 1961. It was he who had a truly revolutionary idea in 1966. During

the Christmas festivities he said to Peter Dornier, "We should design and engineer a positively controlled filling transfer system in the center of the shed. Nobody has such a system, but we can do it".

In spite of many setbacks and difficulties the initial development of the rapier weaving machine was completed in only seven years. The fact that during the subsequent 35 years of industrial development and up until this day no comparable innovative concept has been put on the market illustrates how much inventive spirit was present in DORNIER engineering at the time. Today the spec-

trum of materials and fabrics which can be processed with the rapier weaving machine ranges from the finest pure silk fabrics, greige and multi-colored cotton goods, woolen and worsted fabrics, mattress ticking, home fashions, decorative and upholstery fabrics to heavy industrial fabrics made from jute, wire, glass roving, monofilament, carbon fiber, aramid and tapes. Thus is the machine capable of satisfying the needs and requirements of the apparel, home fashions and industrial fabric weavers.

Good business with the special machines supported the development of the rapier weaving machine during hard times. A large film stretching machine was delivered to the Japanese company Fuji-Film in 1967. In 1969 the rapier weaving machine also penetrated international markets: an initial order was received from the Swedish upholstery fabric weaver Oskarström. Then followed orders from the American companies Dorr Woolen and Anglo Fabrics, then later Collins & Aikman, at that time the largest manufacturer of upholstery fabrics in the USA. These orders started an avalanche of subsequent orders from companies such as Milliken, Riegel and Chatham. In December 1969 the first rapier weaving machine was delivered to the worldwide leading Italian woolen weaver Cerruti 1881, a company which would become decisive as regards the further development of the machine.

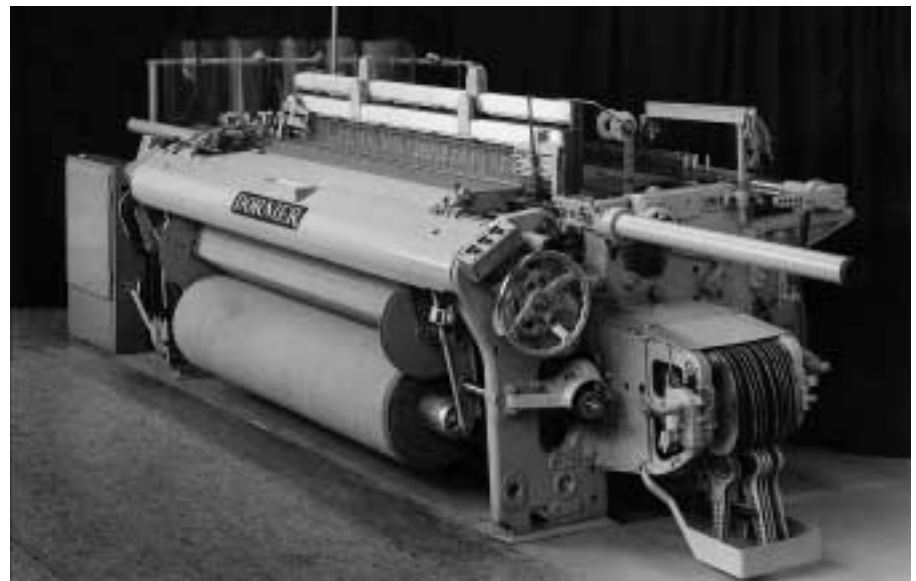

The first generation DORNIER Rapier Weaving Machine

On December 5, 1969 Prof. Claude Dornier died at the age of 85. Lindauer DORNIER has his farsightedness in developing the weaving machine and special machine businesses and to carry on with these developments even when pushing forward with aircraft construction to thank for its existence today.

1969 to 1985: the international breakthrough

As the advantages of the DORNIER Rapier Weaving Machine spread throughout the industry, rumors again began to spread to the effect that DORNIER would soon make the decision to concentrate exclusively on aircraft construction. To counteract this an unusual marketing strategy was implemented: trial machines were installed at customers' facilities to convince them of the product. The Belgian textile company Bekaert had already purchased a tenter frame in 1955 and is a good example of many years of good customer relations with DORNIER. The weaving machine demonstration so convinced Bekaert that as a result this company even today is one of the largest customers for DORNIER weaving machines. Following the international breakthrough with the rapier weaving machine, DORNIER invested in the expansion of the engineering shop in 1970

with the addition of a second floor, thus significantly increasing production. The 1000th rapier weaving machine was shipped to Craigs in Scotland.

In September 1973 Nikolaus Kokkinis died after a decade of inspired inventive spirit which had so significantly influenced the development of the weaving machine.

The technology of the DORNIER Rapier Weaving Machine could also be marketed at this time with the concluding of the first licensing agreement in India. Even in Switzerland, the country with the strongest competitive companies Sulzer, Rüti and Saurer, the rapier weaving machine from Lindauer DORNIER began to break through into this market. In March 1978 American DORNIER Machinery Corporation (Amdo) was founded in Charlotte, North Carolina, USA, one of the most important export countries. At the ITMA 1979 in Hannover in addition to a further improved rapier weaving machine, the continuous mercerizing machine was presented for the first time. The patented circular expander enabled tubular knit goods to be mercerized for the first time without selvedge marks.

On January 31, 1982 Peter Dornier celebrated his 65th birthday and at almost the same time, the 15,000th weaving machine came off the production line.

The enterprise was flourishing; in 1981 gross sales had grown to in excess of DM 150 million and in 1982 increased to DM 180 million. At the Lindau-Rickenbach facility a new spacious building for weaving machine demonstrations, final gearbox assembly, and the sales and marketing departments was completed. As a result practically all the possibilities for further building projects were exhausted. And since no suitable building land could be found in Lindau, in April 1985 Peter Dornier leased a fabrication facility for special machines in Essersweiler in the Achberg community.

The performance achieved by the company received official recognition during a ceremony in June 1983 when Peter Dornier received the Bavarian Order of Merit from the Bavarian Prime Minister Franz-Josef Strauß.

1985 to 2000: the step to independence

A decisive turning point in the history of Lindauer DORNIER GmbH came in 1985. Since its founding in 1950 the company had remained part of the DORNIER Group. As Daimler-Benz acquired a majority shareholding in the group in the summer of 1985, Peter Dornier assumed sole ownership of Lindauer DORNIER GmbH within the framework of a stock swap. The branch



The DORNIER Rapier Weaving Machine installation at the Spanish company Iberica de Confecciones 1976



Clips closer on a DORNIER transverse stretching machine

manufacturing facility in Essersweiler was further expanded, and this facility became the center for the entire fabrication and assembly of special machines. In the main facility CNC machining centers, in-house plastics manufacturing, and an electronic research and development department were introduced.

When Peter D. Dornier, the son of Peter Dornier, joined the company in 1989 Lindauer DORNIER was faced with a difficult situation in world markets. In the case of special machines gross sales abruptly became retrogressive. Business with video and magnetic tape after the boom in the 80's was now in recession.

However, an upswing in business came relatively quickly and was largely due to a market development that occurred in India in 1993. In order to keep perishable foods longer in tropical climates, polyester film was in demand and being used more and more for packaging purposes. Since the Indian company entrusted with the project for such installations did not possess the necessary experience, it was necessary for one supplier to offer a complete engineering service for the installation of complete plants. Here Lindauer DORNIER trod on new ground. Up to this point the main focus in Lindau had been on the manufacture of the special machines themselves. Now it was suddenly necessary to undertake engineering assignments in connection with the sup-

ply and installation of complete production lines.

In order for a medium sized enterprise located in Germany to compete internationally with large companies, there was only one way for Lindauer DORNIER, a way that has been resolutely followed to this day: technological leadership. It is mostly customers – often technological leaders in their own field – who challenge Lindauer DORNIER to ever higher levels of performance and improvements. One measure of technological leadership among many is the number of patent applications. Peter Dornier himself during his career had 45 patent applications and each year an average of 15 patents are applied for by the company.

In the area of weaving, the company introduced a new airjet weaving machine in 1988. The system of filling insertion by means of compressed air was incorporated into the existing frame of the rapier weaving machine. The new airjet weaving machine also incorporated, at that time for the first time, a new electronic control and monitoring system with CAN-Bus, which offers a high degree of flexibility and functionality and also has an open architecture to accommodate future developments. Today, more than 10 years later, over one third of total weaving machines produced are airjet weaving machines. There is an upward trend. In 1991 for the first time a system family of weaving machines consisting of rapier and airjet weaving machines was presented at the ITMA in Hannover. In addition, this exhibition saw the world premier of the Quick Style Change (QSC) system developed by DORNIER.

For the time being at least, the high points in the history of the development of weaving machines were demonstrated by Lindauer DORNIER at the ITMA 1999 in Paris. In addition to the introduction of a completely new family of selvedge formation devices, at the same time the widest airjet weaving machine ever built, with a nominal width of 430 cm and equipped with an electronic jacquard machine, was exhibited. This airjet had a filling insertion rate of 2,500 m/min. Simultaneously a new fashion trend in the area of circular knit goods –



Group of subnozzles on a DORNIER airjet weaving machine

seamless underwear with a Lycra blend – led to the presentation of a heat setting machine, type EcoFix®. The heart of this machine is the patented circular expander from the series of finishing machines, which enables circular knit goods to be processed in tubular form.

Development is ongoing. Globalization, worldwide business to business networking with an increasing concentration of companies, as well as significant economic and financial crises as recently experienced in Asia and Russia are all challenges facing DORNIER today. The enterprise is building its future on those qualities that have made the company a successful supplier to specialized markets during the last 50 years. In this tradition and with an exceptional response to



Company owner Peter Dornier with his son Peter D. Dornier

challenge and opportunity, Lindauer DORNIER is being led toward a secure and successful future by the son of the

founder among a group of 2nd generation executives.

Examples in technological leadership and innovation

- | | | |
|--|--|---|
| 1965 Positive filling transfer on the rapier weaving machine (patented) | 1993 Universal support plate for quick change from tucker to leno selvedge on rapier weaving machines* | 1999 Nominal width for airjet weaving machines up to 430 cm |
| 1967 Spring loaded clamp in the rapier head (patented) | 1994 Weaving 8 different pick densities, warp tensions and speeds | 1999 MotoLeno with independent direction of rotation* (patented) |
| 1967 Open shed weaving | 1995 Pattern change on the fly with the rapier weaving machine running | 1999 New filling stop motion, "Triple Weft Sensor"* (patent applied for) |
| 1970 Reversible maltese cross cramming motion (patented) | 1995 Drive for jacquard machine with 10,000 hooks | 1999 Self centralizing automatic harness frame connector PSL* (patented) |
| 1981 Leno device (patented) | 1995 Drive for jacquard machine with 10,000 hooks | 1999 Universal undermotion Autolub |
| 1989 CAN-Bus | 1996 PneumaTucker pneumatic tucker* (patented) | 1999 New rotating whiproll* (patented) |
| 1989 Bilateral reed drive on airjet weaving machines | 1996 Disc-O-Leno full-turn leno device* (patented) | 1999 Electronic thread tension device with integrated filling stop motion for the rapier weaving machine* (patent applied for) |
| 1989 Fabric support table for airjet weaving machines | 1997 Modular construction for quick change from full-width temple independent of width to cylinder temples on rapier and airjet weaving machines* | 2000 Automatic rear shed setting, AutoWarp* (patent applied for) |
| 1990 Bilateral width adjustment on airjet weaving machines* | 1998 EcoLeno double full-turn leno device* (patented) | 2000 Fast Dobby Change, FDC (patent applied for) |
| 1990 Sensor in breast beam and/or whiproll* (patented) | 1998 Positive permanent control of the entire pneumatic filling insertion on the airjet weaving machine, Type PIC (patented) | |
| 1990 Electronic take-up and let-off motions | 1998 Modular construction for quick change from tucked to leno selvedges on airjet weaving machines* | |
| 1990 Start mark prevention with higher speed of motor (patented) | 1998 Drive for jacquard machine with 20,000 hooks | |
| 1990 Rib-raceboard* (patented) | | |
| 1991 System family of rapier and airjet machines | | |
| 1991 8-color on airjet weaving machine | | |
| 1991 QSC System (patented) | | |
| 1991 Swivel-temple assembly* | | |
| 1993 Stepping motor technology for color selector* (patented) | | |
| 1993 Stepping motor for brake and scissor* | | |

* All these developments have been designed and engineered to be retrofittable to existing machines.

175 years Arnold Kock GmbH & Co. KG in Steinfurt, Westphalia

CONGRATULATIONS!

During the time Lindauer DORNIER GmbH was making a name for itself for technologically mature and market oriented products as a medium sized enterprise, many of our customers were placing similar emphasis in their own company philosophy. A whole series of these customers are celebrating notable birthdays this year, one that stands out being the textile company Simonis in Verviers, Belgium which specializes in the manufacture of billiard table cloth and can look back over an astounding 320 years of existence.

In the following pages and representative of many of our customers celebrating their jubilee this year, we would like to present five companies from various areas of woven fabric production, and at the same time illustrate the wide spectrum of application offered by our rapier and airjet weaving machines.

HI-TECH TEXTILE ENTERPRISE OF EUROPEAN CLASS AND STRUCTURE

Messrs. Arnold Kock has been a family business since the company was founded in 1825 in Münsterland. During its 175 years of existence this company has developed into one of Europe's leading textile enterprises. A major reason for this is the specialization on jacquard fabrics, which Kock brings to market in an unmatched variety and quality. Kock covers the entire process cycle – from spinning new fiber to delivering finished products ready for market. This offers decisive advantages: on the one hand the precise monitoring of the product and total quality control, and on the other hand the philosophy of Kock is a dynamic approach to the market oriented toward growth, ready to take risks and make investments, and a quick response to change.

Each year 120 million square meters of fabric for napery, top-of-the-bed products, glass cloths and decorative fabrics are produced by Kock in Westphalia for two markets, namely retail and specialized stores, and the contract business. The main emphasis in the retail and specialized stores business is the depth of the product range and a high level of customer care. The contract business places very high demands on the fabrics and finishing processes. The company is well known in both markets for the width and depth of the product range. In addition to European standard sizes, oversized and

customized cut and sewn products are included in this range, and all this in the quality required by the customer and demanded by the market. The Kock facility is equipped throughout with state-of-the-art machinery, keeping pace with the requirements of a constantly changing market. It is thus not surprising that it is here where the first 430 cm nominal width airjet weaving machines equipped with jacquard machines delivered by DORNIER are installed. Also Kock decided on the DORNIER System Family since in addition to these airjet weaving machines also rapier weaving machines are installed to weave the very wide spectrum of fabrics produced. Kock recognized opportunities in Europe at a very early stage and has taken full advantage of these chances. The company has efficiently implemented a strategy of participation and diversification, and purchased production capacity as well as knowhow. This strategy created time and cost advantages. Production processes are optimized, the manufacturing program streamlined and new markets developed. The company also manufactures in various other European countries. And of course all Kock products fully meet international environmental protection standards. We wish this textile company and all 2500 Kock employees a successful jubilee year and a keen eye for continued technological progress and prosperity.



The DORNIER Airjet Weaving Machine installation at Kock

A PASSION FOR TEXTILES



In 1825 up in the hills near Zurich, Jakob Zürrer laid the foundation stone of a company converting fabric produced on the looms of a cottage industry in nearby farmhouses. In 1870 with the purchase of the first mechanical loom to weave silk, the company started its own manufacturing facility and intensively developed trade relationships in international markets in Europe and overseas. The popularity of Zürrer silk fabrics contributed to Zurich becoming famous as one of the main silk producing centers in Europe. It was particularly the very fine lightweight silk fabrics produced by Zürrer which were extremely successful.

The change in fashion necessitating heavier fabrics caused the company to build its own machines to produce these fabrics.

In 1905 the third generation took over the management of the company and subsequently intensified the international connections with the founding of Zürrer Silks and Lancashire Silk Mills in Darwen, England. At this time the name Weisbrod was added through marriage. The fourth generation with Hubert, Richard and Hans Weisbrod, after making a difficult start during the war years, could profit from the boom following the end of the war. During this period Weisbrod-Zürrer concentrated on diversification and integrated manmade and synthetic yarns into

the manufacturing program. When the enterprise became a private limited company in the mid 80's, Ronald Weisbrod joined the company representing the fifth generation. In 1984 he assumed the leader-

ship of the company following the death of his uncle.

The company made its name from very exclusive raw silk fabrics. The artistic talent of the new company chief began to effect a shift in emphasis. Today Weisbrod-Zürrer has a reputation of being one of the leading houses for high fashion ladies outerwear fabrics, for necktie fabrics and during the last few years also innovative decorative fabrics, all produced exclusively on DORNIER rapier weaving machines. As a converter, the company supplements its own collection with other fabrics, paying particular attention to maintaining the creative handwriting of the Weisbrod-Zürrer House. In addition to a highly demanding level of creativity the company places great significance on an intimate relationship with its customers, on an uncompromising quality control and a state-of-the-art manufacturing operation. We congratulate Weisbrod-Zürrer on its 175th birthday and wish the company continued success on the stage of the international fashion scene.



The DORNIER Rapier Weaving Machine installation at Weisbrod-Zürrer

“OBSESSION” THE FINEST WORSTED FABRIC FROM 13.9 MICRON MERINO WOOL



Fine worsted weaver Bower Roebuck is located south of Huddersfield in an area rich in the tradition and craftsmanship of fine worsted weaving. Founded as Glendale Mills 100 years ago, the company has been for the last 25 years part of the Scabal Group, known throughout the world as the Premier Cloth Merchant House. Thanks to significant technological advances in the textile industry over the last few decades and also the tradition of craftsmanship, Bower Roebuck has become one of the leading manufacturers of exclusive fine worsted fabrics for men's suiting and jackets worldwide.

The first DORNIER rapier weaving machines were introduced more than 20 years ago. Today the company is weaving with the third generation of this type of weaving machine, following a program of replacing older machines with new ones. Bower Roebuck places great importance on weaving exclusive worsted fabrics with tucked selvages. In addition these are woven as name selvages to the particular requirement of each individual customer. Electronically controlled name-jacquard machines are used for the high definition woven name selvages.

But what's behind the claim that fabrics woven by Bower Roebuck are produced from the finest wool ever spun. The reason lies in the use of the finest merino wool with a fiber diameter of less than 14 microns, spun to a count of Nm150/2. According to Alan Williams, weaving manager, during the weaving process this very fine but weak yarn is prone to thread breaks and the fabric prone to start marks. As a result of the very kind action of the filling insertion system on the DORNIER Rapier Weaving Machine with low tension peaks and the comprehensive start mark prevention program ASP, the highest level of productivity and quality is guaranteed. Finishing is also a decisive factor as regards fabric quality, utilizing the softest water in all of Europe.

Technological advances in weaving and finishing are inherently connected to Bower Roebuck's desire to constantly improve product quality. In order to achieve this the company sees a future where it will work in close partnership with its

customers and specialized machinery suppliers such as Lindauer DORNIER GmbH. Both companies will profit from further technological advancement of the weaving machine to provide optimum utilization. We congratulate Bower Roebuck and wish the company a further 100 years of success.



From l to r: Executive Director Ronald Hall, John McBride (Allertex agency) and Production Manager Alan Williams

PRECIOUS FABRICS FOR THE VERY FASHION CONSCIOUS

Wilhelm Zuleeg GmbH, today under the direction of the third generation, Stefan Zuleeg, Klaus Zuleeg and Michael Kaminski, understands not only being a weaver, but also being a supplier of a system. Solutions are developed in a close cooperation with customers aimed at a mutual goal: perfect fashion from perfect fabric. Wilhelm Zuleeg GmbH manufactures exclusive greige and multi-colored coordinated fabrics for ladies' and men's outerwear. The strength of the company lies in the production of exclusive fabric designs of excellent quality from specially selected raw materials. These fabrics are woven on 68 DORNIER rapier weaving machines.

An appreciation for the exceptional beauty of a precious fabric connects Wilhelm Zuleeg GmbH with other people around the world. In spite of the latest technology, efficient logistical systems and an unswerving customer orientation, it is above all the fine feeling for the requirements and trends of the market, which has made Zuleeg GmbH a valued supplier to internationally well known fashion

houses. Companies such as Escada, René Lézard, Cinque, Anne Klein, Kenzo, Klaus Steilmann, Michael Kors, Ellen Tray and many others are included in its customer circle.

The driving force is ongoing further development both aesthetically and technically. This includes the 125 employees, which Zuleeg GmbH is convinced make the difference. This refers to their potential for creativity as well as craftsmanship and their great concern for the requirements of customers. The company does a lot to promote up and coming young people and cofounded the Helmbrecht Textile Forum with five other textile companies. This enables these six medium sized textile companies, even though up to a point they compete with each other, to make full use of the synergies created and reach common goals quicker and better. How much innovation and progress counts in an old established company like Zuleeg GmbH is illustrated by the company's participation in a European network of companies, who are endeavoring to introduce new methods of

management into the textile apparel chain. This is a virtual organization, Vertex for short, which utilizes the latest communication and information technologies. In the fashion oriented apparel weaving industry in which Zuleeg GmbH is involved, an entire range of new patterns must be created year after year. It is useful to investigate possibilities in an effort to limit the range somewhat and obtain a quick feedback from customers. With simulations of actual yarns from spinners, Zuleeg GmbH tries to visualize the fabric being developed and use this as a basis for discussion with the ready-to-wear clothing manufacturer. This quick and selective exchange of design information between the producer and the customer – also via the Internet – can lead to a reduction in cost and a quicker realization of creative fashion ideas in the future. We wish Wilhelm Zuleeg GmbH a full order book, satisfied customers throughout the world and a continued openness to anything new.



Fashion show at Zuleeg during the 75 year jubilee celebrations

KISSING FROGS OR HOW TO FIND AND DEVELOP SPECIALITY MARKETS



The DORNIER Rapier Weaving Machine installation at Southern Mills

The eventful history of Southern Mills, Inc., began in 1925 when the father of the current president of the company William D. “Doug” Ellis purchased two machines to knit heavy cotton padding for laundry presses. This laundry program “Fabricare” generated a large amount of business for 50 years. When this market began to stagnate, it was time to start kissing frogs – hoping to find a prince that would allow the company to continue to grow.

Replacement automobile seat cover fabrics provided such a chance and this business was a hot item from 1939 until the mid 50’s. Later a green needlepunched outdoor carpet for miniature golf courses was developed for Monsanto. It was also tried on tennis courts and golf greens, but without success. Southern Mills also developed a heavy needlepunched pad for Monsanto to go under the company’s Astroturf for football fields and also a blaze orange Acrilan fabric for hunting garments. The company tried its hand

with thermal blankets, walk off mats, mop yarn, and meat netting, and all these frogs were only frogs. Then in the mid 60’s two frogs turned into princes. The first was a grass catcher bag for lawn mowers. The fabric was woven and cut and sewn into bags by Southern Mills. Soon well known mowing machine manufacturers in the US such as Murray, Jacobsen, Toro, Snapper and John Deere were customers and a business in Europe flourished.

In 1964 Southern Mills kissed the second frog and started to process the new fiber “Nomex” developed by DuPont. The fiber was as tough as nylon, but it would not melt or burn under normal conditions. First the inner lining fabrics and then the outer shell for firemen’s coats and pants were produced, later NASA accepted the fabric for astronauts’ suits. Today, Southern Mills is the largest manufacturer of fire protection garments in the USA. The petroleum industry and munitions manufacturers are also supplied

with fabrics produced from other high performance fibers.

Using state-of-the-art machinery labor costs have been reduced to only 7.5% of the sales price, and here 92 DORNIER rapier weaving machines make their contribution. The education levels of employees have been continuously improved with the company introducing an education program in the mid 80’s. The company is well equipped to meet the challenges of the future, and it only remains for us to wish Southern Mills continued success and changing many more frogs into princes.



Space shuttle crew in Southern Mills space suits

NETWORKING REDUCES COSTS

Global competition, whether it be in very cost influenced commodity fabrics or even new fabrics influenced by fashion trends, necessitates shorter production cycles and reduction in cost. To achieve this we must improve the flow of materials within the plant and the availability of production machines as well as relieving the strain on personnel. For this purpose modern methods of communication are tools that the mill cannot do without and their effective deployment is an important topic of conversation in any discussion concerning future planning.

With the new concept offered by the DoNet Global Communication Network, DORNIER provides the customer with the means to monitor and control electromechanical sequences, process style data and patterns, collect and evaluate data, operate machines by remote control, Teleservice, on-line control of quality and productivity, on-line declarations concerning production status and faults, on-line assistance and programmed remote maintenance procedures. Calling up the user manual corresponding with the

machine on the machine display is just as possible as ordering spare parts using EPOS directly on the display via the Internet or a modem.

The 4 levels of communication

Level 1

At the first level all machine modules and auxiliary devices communicate with each other in real time. This is facilitated over the Internet and external CAN-Bus, which has been operational since 1989 in identical form in DORNIER airjet and rapier weaving machines.

Level 2

At the second level the clear definition and simple structure of the electronics are secured for the user. By means of a graphical machine display similar to the emulation offered by Windows programs, functional security is checked and instructions given, thus securing the dialog between man and machine.

Level 3

In order to decisively improve the communication with the weaving machine in

the future, the data processing and administration program DoWeave has been created as a central interface for the third level. DoWeave replaces the old programs DoStyle and DoTech and is useable as an independent off-line program as well as online with the machine via the Ethernet connection. The program offers style and pattern administration together with a networking capability as well as the potential to administer and process conveniently structured weaving machine data. Furthermore, in the future any weaving machine equipped with the Dialog Panel II can be networked and operated by remote control just as if the operator was standing at the machine.

The program also enables machine diagnoses to be carried out as regards machine settings, stop protocols and pattern information. Using Windows emulation the machine values can be compared on the monitor with appropriate standard values stored on the PC. With the click of a mouse these comparisons can be transferred from the weaverroom office to the machine, or vice versa.



Graphical color display on the weaving machine

The series Ethernet connection is the prerequisite for such an open communication, offering the following advantages:

- open architecture
- economical networking
- bidirectional audio-visual transmission
- indirect Internet access
- prerequisite for the DoTes teleservice

Data can be exchanged with the machine offline using diskettes. For older machines transfer memory cards are available for this purpose.

The combination of DoWeave with external data collection and evaluation systems offers a wide variety of potential evaluation procedures independently

from the software supplier. Among the most noteworthy are:

- backtrack module with which the complete history of events of a piece can be traced back via cloth inspection, weaving and even warp preparation
- automatically actuated maintenance protocols and spare parts analysis

Global Communication Network DoNet

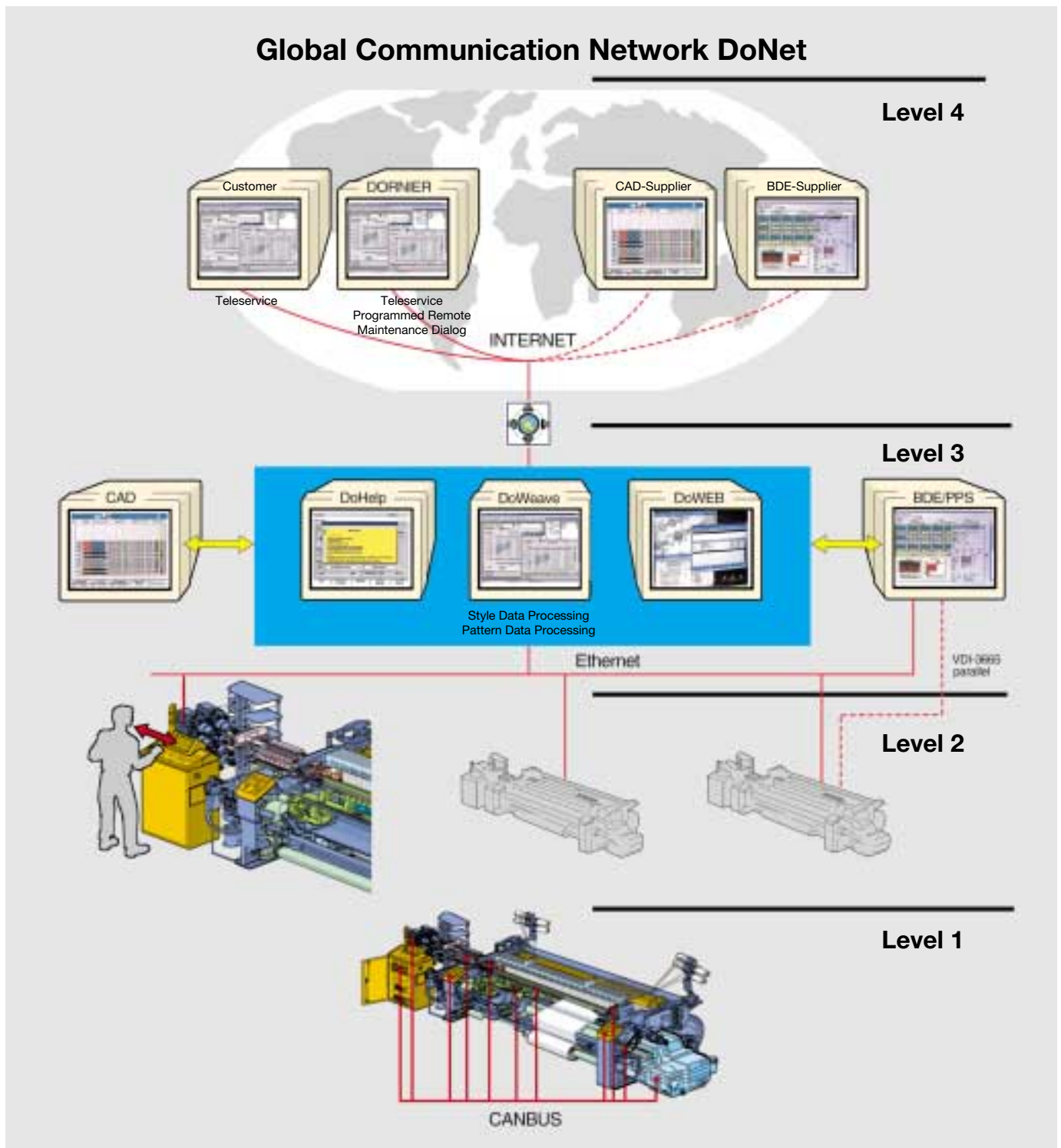



Communication via monitor from the customer to DORNIER

- quick response to incidents through the alarm server, which alerts the person responsible at the PC or by cellular phone

In order to include older DORNIER machines, or machines from other manufacturers in the network via the data collection and evaluation system, the VDI-3665 interface already available, or alternatively parallel Interfaces can be utilized.

With modern CAD/CAM systems the exchange of pattern and settings data with DoWeave is secured via a simple data interface.

Securing the dialog between man and machine is facilitated by means of an on-line help program, called DoHelp. Using this program the individual help parameters can be called up on the display on any machine in the network.

Level 4

The fourth level of communication is the connection of the machines at the production facility with external contributors such as branch officers, design studios or machine suppliers.

Utilizing as a basis the DoWeave, Ethernet connection and the Machine Dialog

Panel II, this creates DoTes, a teleservice for remote maintenance and service dialog between DORNIER and the customer via a modem or the Internet. As already mentioned in connection with Level 3, using Windows emulation machine data can not only be compared with standard values stored on the PC in the weaveroom offline, but also with values maintained by the weaving machine manufacturer. A mouse click is all that is necessary to move data from the machine to the manufacturer, or vice versa.

The connection between the weaving machine network at the customer's facility and the machine supplier is protected by a customer filter or firewall.

The expectations expressed by the industry for further support in the form of process, maintenance and spare parts diagnostics can only be satisfied through long term analysis utilizing data collection and processing systems. Evaluation protocols as outlined in the section covering Level 3 can be deployed at external workstations so long as they can be supported by data collection and processing system suppliers. The cost effective audio and visual connection possible over the Ethernet link becomes the extended arm of the service center on location.

Even menu controlled downloading of new monitoring and control software can be carried out via modem or over the Internet.

Another significant feature optimizes functionality and security, namely the downloading of the respective instruction manual and the corresponding EPOS spare parts catalog via the dialog panel on the machine. With a corresponding networking of the machines, the online placing of an order to spare parts directly on the machine display via modem or over the Internet is feasible. This is possible thanks to the windows emulation DoWEB, which converts the machine display to a windows desktop.

For customers ordering spare parts in the future over the Internet, we give a 2% discount on currently valid prices. We ask endusers not yet registered to contact a service provider and access the Internet.

The advantages of the DoNet global communication concept – a cost effective modern and future-oriented system – can be summarized as follows:

- an even closer and more responsive relationship between the customer and the supplier
- conserving costs by utilizing a quick and cost effective spare parts ordering procedure
- better documentation
- quicker communication of data
- possibility of remote diagnosis and tele-service
- saving in personnel costs through more effective planning
- improved quality control.

EXTENSIVE FLEXIBILITY THROUGH ADAPTABLE MACHINES

The rhythm of development in the textile industry is quickening and the effect permeates all aspects of the market. When new yarns and fibers are first introduced on the market, their processing parameters initially remain unknown. In addition fabrics are constantly finding new areas of application, or there are ever increasing demands from the customer to be satisfied. This scenario makes decision-making regarding a specific machine configuration for an imminent investment more difficult than ever before.

deployed. This simplifies the entire organization.

For many years DORNIER has also followed the practice of developing new machine components in such a way that they can be retrofitted to existing machines. Using the CAN-Bus in the field of electronics has supported and enhanced this effort. Thus customers are provided with a high degree of surety at the time an investment is made and should at the moment unknown and in the future possibly decisive machine

parameters be necessary, they are in fact already available. And at the time required these parameters can be utilized to quickly satisfy new demands with little difficulty. Even today new monitoring and control software can be downloaded online via modem or over the Internet.

The deployment of the system family enables weavers of exclusive high fashion fabrics on rapier weaving machines to consider today adding staple articles to their manufacturing program. Then producing exclusive high fashion fabrics side by side with staple articles is in fact an economic proposition when airjets are utilized for the latter. These considerations are also valid to some extent in the production of industrial fabrics.

Rapier weaving machine

The rapier weaving machine offers a whole series of possibilities to guarantee the quick adaption of the machine to new trends. These features are already built into the system and include the positive filling transfer in the center of the shed, open shed filling insertion and a rigid rapier, which operates without the necessity of guide elements in the shed. The extremely low filling tension, supported by an electronic filling tension device provides a high degree of independence from the varying yarn quality or

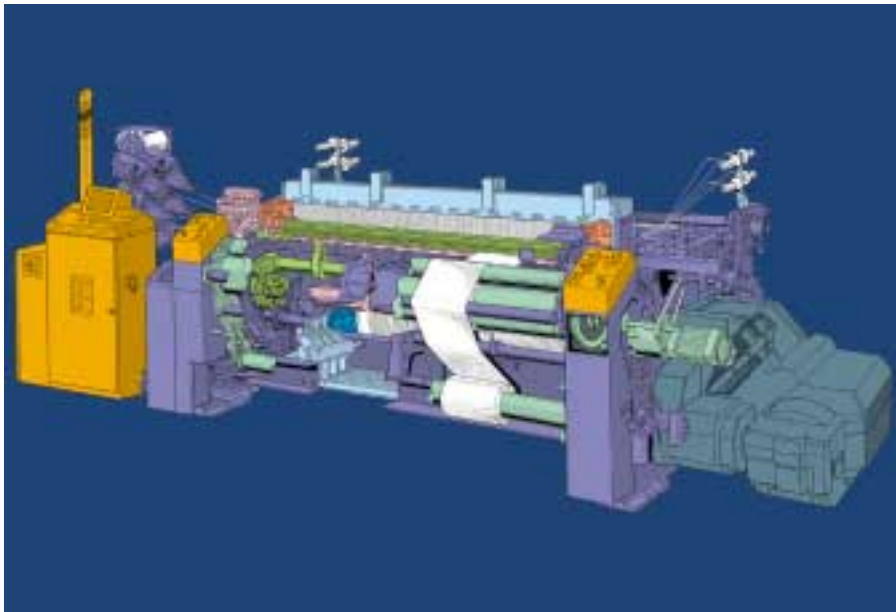

DORNIER Airjet Weaving Machine, Type A

System family

Some 10 years ago DORNIER started to develop a system family of rapier and airjet weaving machines in order to offer customers an optimum solution to making the right decision. Utilizing the modular concept right from the outset makes a significant contribution to lower costs and increasing flexibility. In fact, 90% of the electronics and 40% of the mechanical parts used in the rapier and airjet weaving machines are identical to both types. In practice, it has been shown that weavers and technicians with assignments covering both types of machine do not experience any difficulties. In cases where the nominal width of both types of machine is the same, the same accessories are utilized and the same QSC System configuration can be

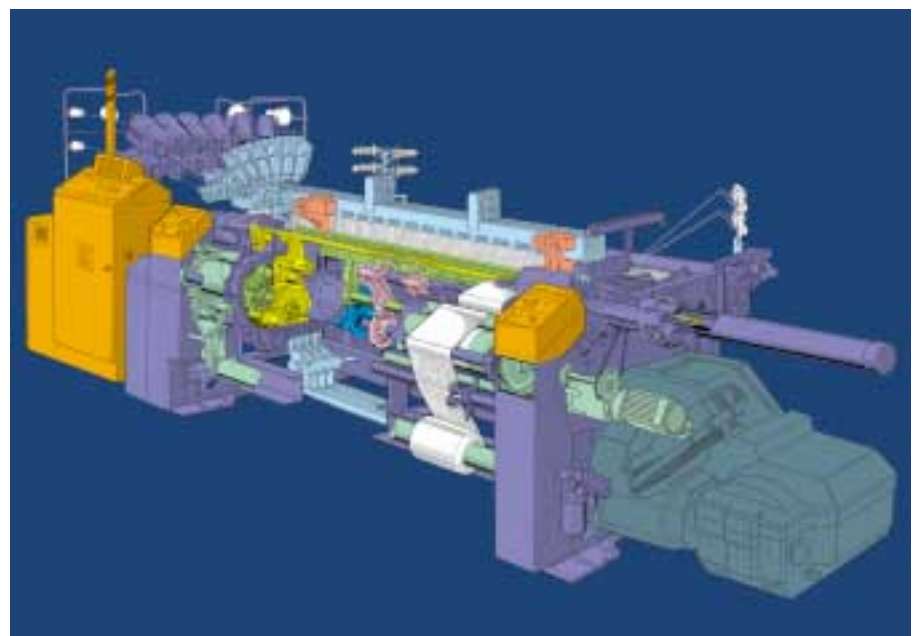

DORNIER Rapier Weaving Machine, Type P



12 color filling selector on the rapier weaving machine

low breaking strength of the filling being inserted. The modular construction of the electronic filling tension device and the color selector enables the number of filling colors to be subsequently increased. This filling insertion system offers an incomparable security of process and thus a high degree of productivity with exceptional flexibility.

The machine offers a unique spectrum of application supported by a wide variety of configurations offering unlimited pos-

sibilities. Application ranges from exclusive pure silk upholstery fabrics with 16 filling colors and jacquard shed formation with up to 20,000 hooks to coated netting fabrics with the coarsest yarn counts in warp and filling and densities of less than 0.5 cm.

Airjet weaving machine

The same considerations for exceptional flexibility were made at the time in relation to the development of the airjet weaving machine. In this case it was easier in a sense to pay attention to all the possible configurations since the basis being used was the rapier weaving machine. The airjet can be equipped with up to 8 filling colors. The security of process for the complete filling insertion cycle is guaranteed by the Permanent Insertion Control System, termed PIC, patented by DORNIER. In addition the spectrum of application could be extended with the addition of a nominal width of up to 430 cm. Here the basis is the robust machine frame with bilateral reed drive and large filling insertion window. Important for the jacquard weaver is the possibility of bilateral width adjustment.

Placing high value on security at the time of an investment also led to the quick adaption to new styles with respect to temple configurations and selvedge formation.

Payback calculation Cam-to-dobby motion

Basic data:

6200 annual working hours, warp length 1800 m, yarn price DM7/kg, warp: Ne50/2, 31 ends/cm, filling: Ne30/1, 25 picks/cm.

Weaving speed with positive cam motion	990 ppm
Weaving speed with doobby	890 ppm
Weaving costs per 100 m with positive cam motion	86.3%
Additional production per machine/year with positive cam motion	11,980 m
Profit/year at DM 2/kg	23,960 DM
Capital investment for doobby approx.	ca. 25,000 DM
Payback period	1.04 years

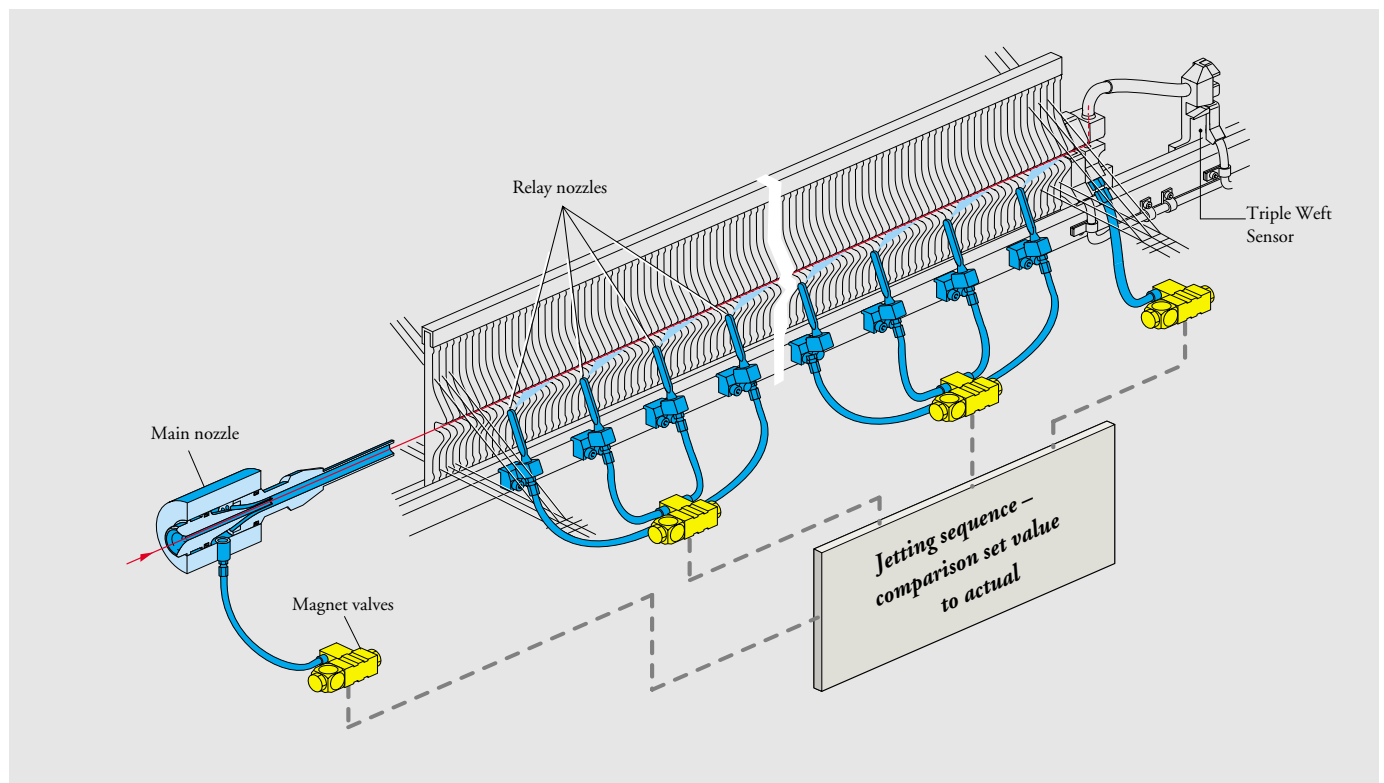

The patented Permanent Insertion Control, PIC

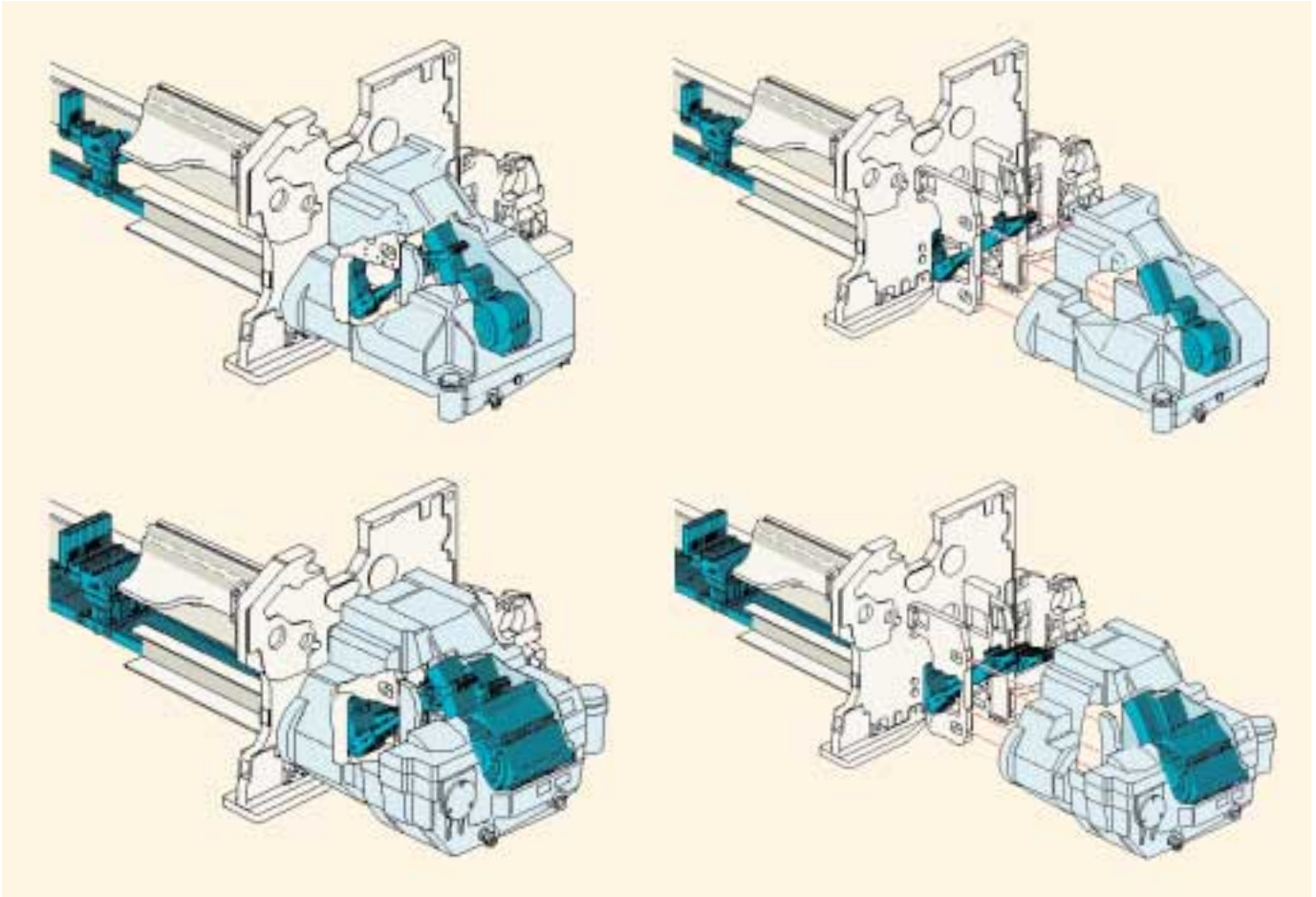

The DORNIER Fast Dobby Change System, FDC

Fast dobby change FDC

In addition, in the case of the airjet weaving machine the Fast Dobby Change system (FDC) is available. This allows the positive cam motions to be replaced with a dobby as a subsequent process incorporated with a style change. Thus the advantages of the positive cam motion in the case of styles with a low number of harness frames, such as cover factor, fabric quality, low ends down and highest weaving speed can be utilized without having to dispense with the advantages offered by the dobby with respect to meeting trends for fabrics with constructions requiring a higher number of harness frames. The calculation on the previous page illustrates the short payback utilizing this system.

Selvages

Tests carried out with conventional selvedge formation devices showed that these lacked reliability and were therefore questioned by DORNIER. This led to

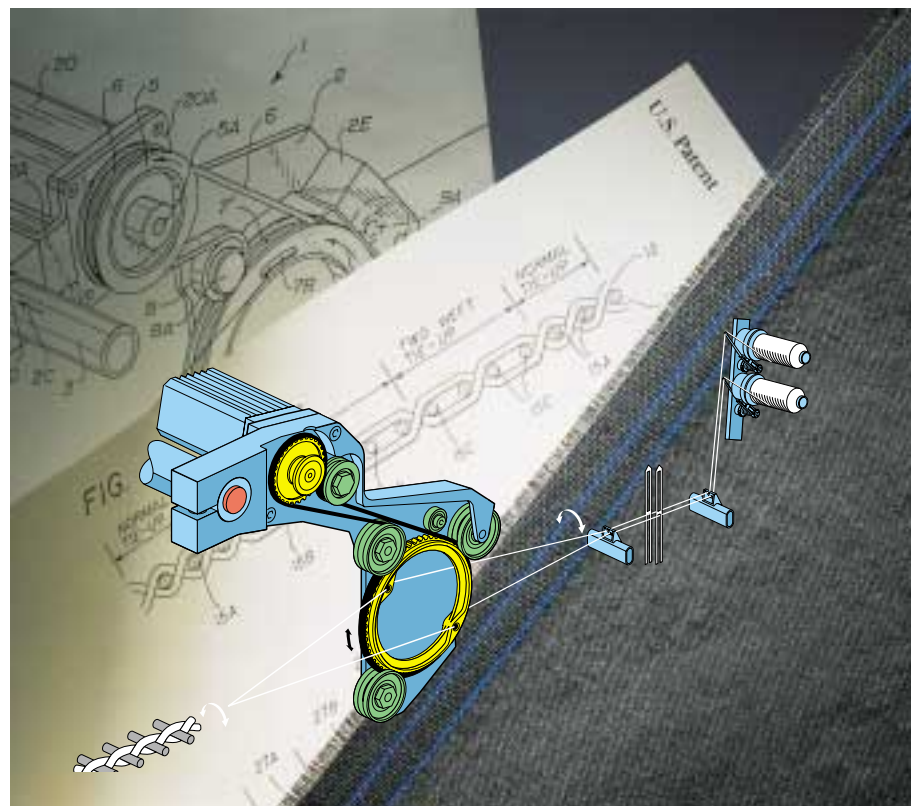

2-end full-turn leno device, Disc-O-Leno®

A WATERTIGHT STRATEGY

the development of completely new systems, which decisively simplified the complexity of the machine by eliminating mechanical components and introducing electronic control. The following devices were developed for use on both types of weaving machine:

- the 2-end full-turn leno device Disc-O-Leno®
- the modular designed double disc leno device EcoLeno®
- the MotoLeno® and EcoLeno® – a disc leno whereby the disc is at the same time the motor
- for airjet weaving machines a pneumatic tucker PneumaTucker® was developed to produce a closed selvedge

Electronics

Over the last few years electronics with the aid of the CAN-Bus have played a decisive role in the simplification of the possible configurations outlined. The elimination of mechanical components, a userfriendly graphical display for a simple dialog between man and machine, the reproducibility of settings, a series Ethernet connection for bidirectional communication and the prerequisite for Teleservice – these are some of the highlights in the modern electronics program developed by DORNIER.

DORNIER provides the necessary security for future decisions regarding investments in new weaving machines with the addition of the DoNet Global Communication Network, which facilitates the connection between the machine, the weaver and the machine manufacturer.

Sioen Industries in Ardoorie has proven that it is possible for a company to maintain a leading position with hi-tech specialized products in world markets. It has been possible for this company with its core activities in fabric coating, manufacturing of protective clothing, production of masterbatches as well as processing fabrics and film materials to connect these so closely with each other that each supplements and strengthens the others. This completely family managed company celebrates its 40th year of existence this year.

Sioen Industries is a worldwide market leader in each of the areas in which it is active. The reasons for this leading position are flexibility in dealing with customers and in production processes, the power of innovation and the will to overcome limitations. And of course the exceptional quality of the products manufactured. This very healthy company, quoted on the stock market in Brussels, continuously invests in new technologies and as a result has the most advanced manufacturing facility in this sector of the industry.

Following the takeover of the French company Saint Frères in 1996, and the Belgian companies TIS 1998 and Veranen Technical Textiles in 1999, Sioen Industries has manufacturing facilities in twelve locations in Europe and a further three cut and sew operations in Tunisia and Indonesia as well as a sales office in China. Production is concentrated in three main areas: coating and fabric manufacturing, fabrication of protective clothing and masterbatches.

Coating

In the field of coating the company maintains an unchallenged leadership. A position that has been attained through efforts to produce quality products and a wide innovative range of products. And last but not least the capacity of the manufacturing facilities, which include the most modern production lines in the world. Coated materials, which the company produces using both methods,

direct and transfer coating, resist water, wind, cold and/or chemicals. New areas of application are constantly being added. In addition to various types of cover, protective clothing, tarpaulins, containers, etc., coated fabrics are also increasingly used for advertising purposes and special applications in medicine. The production lines operate fully automatically, are extremely flexible and are capable of coating fabrics up to 3.30 m in width.

In the past exclusively fabrics from outside suppliers were coated. In 1998 another step was taken in the direction of being a vertical operation when the company opened its own weaving plant. After extensive investigation a decision was taken in favor of the DORNIER system family with an investment in 74 rapier

Insider IMPRESSUM

Publisher and copyright:

Lindauer DORNIER GmbH
Rickenbacher Str. 119
88129 Lindau
Germany
Phone (+49) 83 82/70 30
Fax (+49) 83 82/70 33 86

Editor:

Egon Wirth

Graphic and realisation:

Werbeagentur Vetter
CH-8030 Zürich

Printing:

Lindauer Druckerei,
Eschbaumer GmbH & Co.
D-88131 Lindau

Publishing frequency:

One each year, Date of this issue:
September 2000

Copyright:

Reproduction in part or whole only
allowed with our written permission

Printed in Germany

weaving machines and 13 airjet weaving machines in nominal widths up to 360 cm. Today, heavy industrial fabrics are produced from yarns in counts of 280, 550 and 1100 dtex, which precisely meet the requirements of the company's own coating operations. By operating its own weaving plant the company increased its flexibility and in addition this also facilitated the development of new markets. However, in order to gain complete control over product quality, Sioen is now investing in its own spinning plant for the manufacture of high tenacity PES yarns.

The dynamism of diversification is well illustrated by the companies taken over by Sioen. The manufacturing program of TIS, which weaves exclusively on DORNIER rapier weaving machines, consists of PVC coated fabrics and heavy sailcloth for ocean going sail boats. Veranneman, also a DORNIER customer, covers the areas

of geotextiles, protective mesh and light-weight coated fabrics for example as used in advertising applications. The entire enterprise has a total of 175 DORNIER weaving machines.

Fabrication of protective clothing

In the fabrication departments of Sioen exclusive protective clothing is designed and manufactured for industrial use and sports and leisure wear. This market is undergoing a period of expansion, since protective clothing must meet increasingly more stringent technical and legal regulations. In addition sports and leisure activities on water, in the mountains or in the air have experienced a boost in popularity, and these activities are best served with the use of appropriate clothing. Protective clothing from Sioen is on the one hand resistant and functional and on the other hand the products sell well because they have the right "look". In-house designers produce patterns using

state-of-the-art CAD/CAM technology, and are perfectly and specifically designed to customer requirements.

Production of masterbatches

The processing department is the youngest branch of Sioen. Here in one case two types of masterbatches are produced utilizing environmentally friendly processes: pigment paste and pigment granules. In the second case coated fabrics and film materials are cut for various industrial applications.

Thanks to the flexibility and creativity of its employees, Sioen is able to offer its customers that little bit extra every day. And to make sure that this will always be possible, the bar is raised a little every day.



DORNIER rapier and airjet weaving machines at the Belgian company Sioen

Aerial view Lindau-Rickenbach works



Aerial view Essersweiler works



Aerial view American DORNIER Corp., Charlotte, N.C., USA



Aerial view Pfronten works